

Combination type – CLASS I+II (Clearap)

B12.5VT-385V-FS-3P (CV067539)

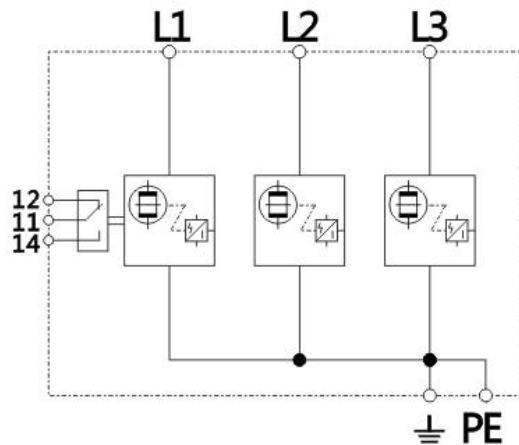

Outside drawing



Basic circuit diagram

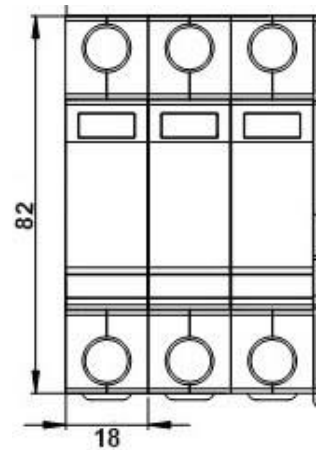

Dimension drawing

Type 1+2 surge arrester designed for low-voltage power supply system protection against surges at the boundaries from lightning protection zone 0_B -2 and higher.

- Class I+II/B+C SPD in accordance with IEC61643-11 and UL1449-4th
- High surge capacity of 12.5kA 10/350 per pole and I_{max} 80kA 8/20
- Reliable supervision due to disconnection device
- Fault indication by red indication flag in window
- With remote alarm terminal optional

Part No.	B12.5VT-385V-FS/3P
In accordance with	IEC61643-11:2011; UL1449-4th
Category IEC/VDE	I+ II / B+C
Max. continuous operating voltage U _c	385VAC
Nominal discharge current(8/20) I _n	12.5kA
Max. discharge current(8/20) I _{max}	80kA
Lightning impulse current(10/350) I _{imp}	12.5kA
Voltage protection level @I _n	<1.8kV
Response time	≤100 ns
Follow current	No
Backup fuse(only required if not already provided in mains)	125A gL/gG
Operating temperature range	- 40°C ~ + 80°C
Cross-section of connection wire	Single-strand 35mm ² ; multi-strand 25mm ²
Torque applied by the screws	2.0-2.5 Nm
Mounting	35mm DIN-rail in accordance with EN 50022/DIN46277-3
Enclosure material	thermoplastic; extinguishing degree UL94 V-0
Housing protection level	IP20
Installation width	3 modules, DIN 43880
Thermal disconnecter	Internal green – normal ; red - failure
Remote alarm contact	Yes
Additional data for Remote Alarm Contacts	Closed and open 1.5mm ² / 0.5 Nm ,max
Remote alarm contact type	Isolated Form C
Switching capability Un/In	AC: 250V/0.5A DC: 250V/0.1A; 125V/0.2A; 75V/0.5A
Max. Size of connecting wire	Max. 1.5mm ² (or # 16AWG)